

- Quartz Temperature Stability
- Small Size
- Hermetic 7 x 5 mm Surface-mount Case
- Complies with Directive 2002/95/EC (RoHS) 

SF2156B

**611 MHz
SAW Filter**

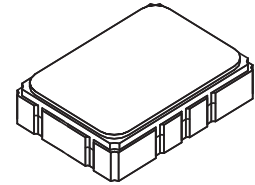

SMP-03-O Case

Absolute Maximum Ratings

Rating	Value	Units
Input Power Level	+10	dBm
DC Voltage	3	V
Operating Temperature Range	-20 to +70	°C
Storage Temperature Range in Tape and Reel	-40 to +85	°C
Suitable for Lead-free Soldering - Maximum Soldering Profile	260°C for 30 s	

Electrical Characteristics

Characteristic	Sym	Notes	Min	Typ	Max	Units
Center Frequency	f_C	1	611			MHz
Insertion Loss	IL_{MIN}			2.8	4.5	dB
3 dB Bandwidth	$BW_{3\text{ dB}}$		7	10		MHz
40 dB Bandwidth	$BW_{40\text{ dB}}$			21	24	MHz
Amplitude Ripple, 609.5 to 612.5 MHz	IL_{MIN}			0.3	1.3	dB _{p-p}
Rejection Reference to 0 dB						
520 to 560 MHz			38	60		dB
660 to 700 MHz			38	53		dB
Source impedance	Z_S			50		Ω
Load impedance	Z_L			50		Ω
Temperature Coefficient of Frequency				-36		Ppm/°C

Case Style	6	SMP-03-O 5 x 7 mm Nominal Footprint
Lid Symbolization (YY = year, WW = week)		RFM SF2156B YYWW

 **CAUTION: Electrostatic Sensitive Device. Observe precautions for handling.**

NOTES:

1. Unless noted otherwise, all specifications apply over the operating temperature range with filter soldered to the specified demonstration board with impedance matching to 50 Ω and measured with 50 Ω network analyzer.
2. Unless noted otherwise, all frequency specifications are referenced to the nominal center frequency, f_C .
3. Rejection is measured as attenuation below the minimum IL point in the passband. Rejection in final user application is dependent on PCB layout and external impedance matching design. See Application Note No. 42 for details.
4. "LRIP" or "L" after the part number indicates "low rate initial production" and "ENG" or "E" indicates "engineering prototypes."
5. The design, manufacturing process, and specifications of this filter are subject to change.
6. Tape and Reel Standard ANSI / EIA 481.
7. Either Port 1 or Port 2 may be used for either input or output in the design. However, impedances and impedance matching may vary between Port 1 and Port 2, so that the filter must always be installed in one direction per the circuit design.
8. US and international patents may apply.

Measurement Circuit

HP Network analyzer

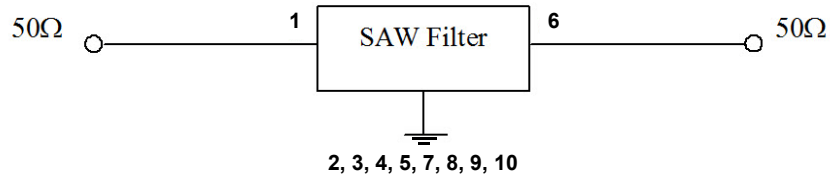

Electrical Connections	
1	Input
6	Output
2, 3, 4, 5, 7, 8, 9, 10	Ground

Filter Plots

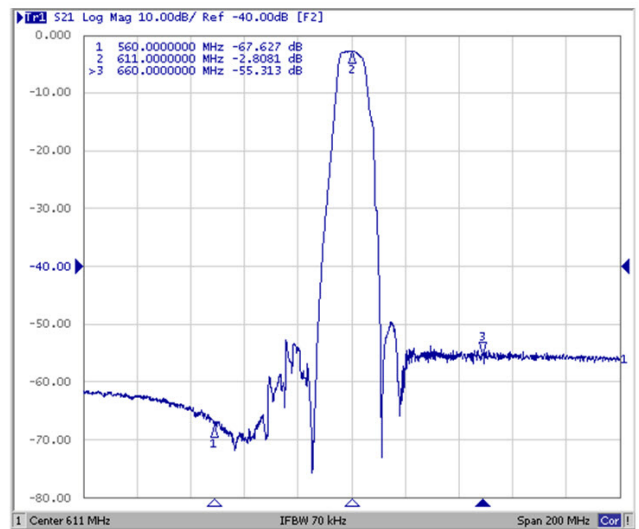
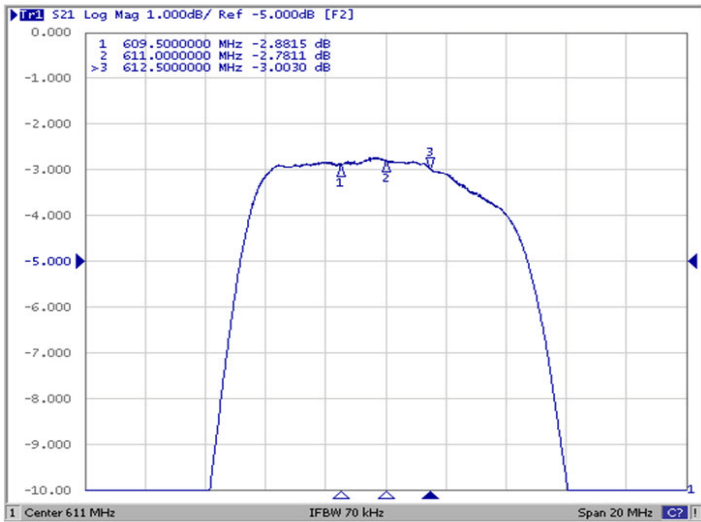

SMP-03 Case

10-Terminal Ceramic Surface-Mount Case 7 x 5 mm Nominal Footprint

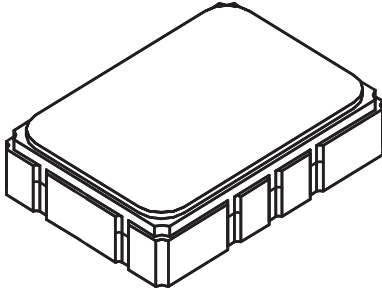

Recommended PCB Footprint

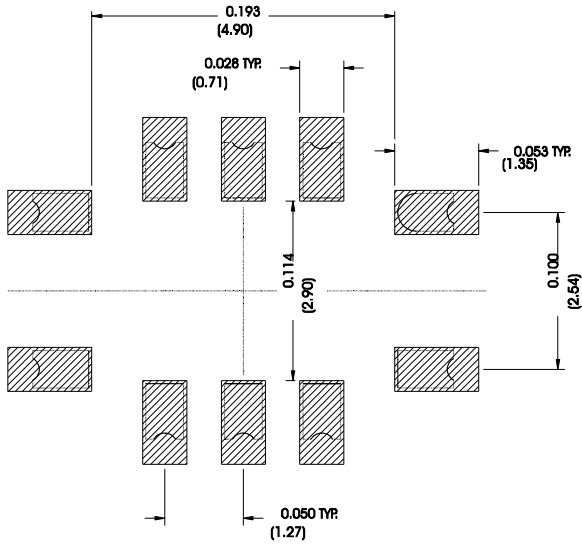

Case Dimensions						
Dimension	mm			Inches		
	Min	Nom	Max	Min	Nom	Max
A	4.85	5.00	5.15	0.190	0.196	0.202
B	6.85	7.00	7.15	0.269	0.275	0.281
C	-	-	1.88	-	-	0.074
D	-	5.00	-	-	0.196	-
E	-	2.54	-	-	0.100	-
F	-	1.00	-	-	0.039	-
G	-	2.54	-	-	0.100	-
H	-	1.27	-	-	0.050	-
I	-	3.00	-	-	0.118	-
J	-	0.60	-	-	0.023	-

Materials	
Solder Pad Termination	Au plating 30 - 60 μinches (76.2-152 μm) over 80-200 μinches (203-508 μm) Ni.
Lid	Fe-Ni-Co Alloy Electroless Nickel Plate (8-11% Phosphorus) 100-200 μinches Thick
Body	Al ₂ O ₃ Ceramic
Pb Free	

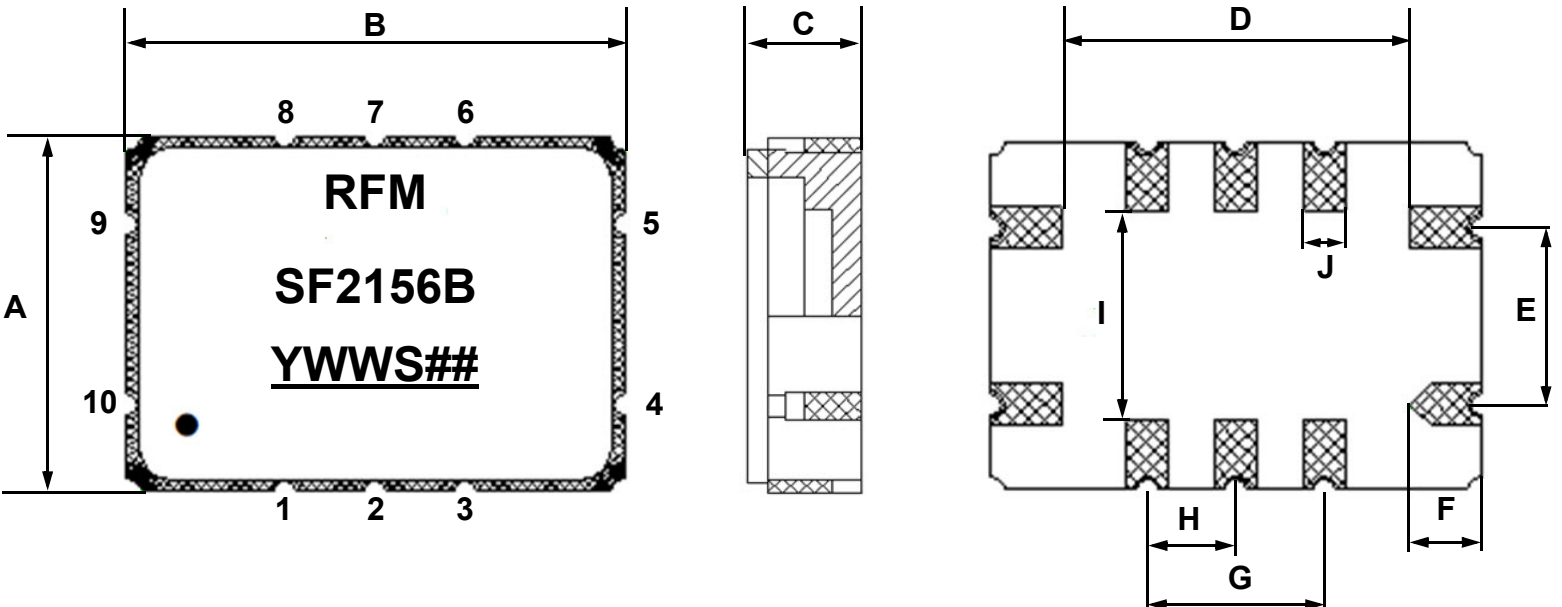

Tape and Reel Specifications

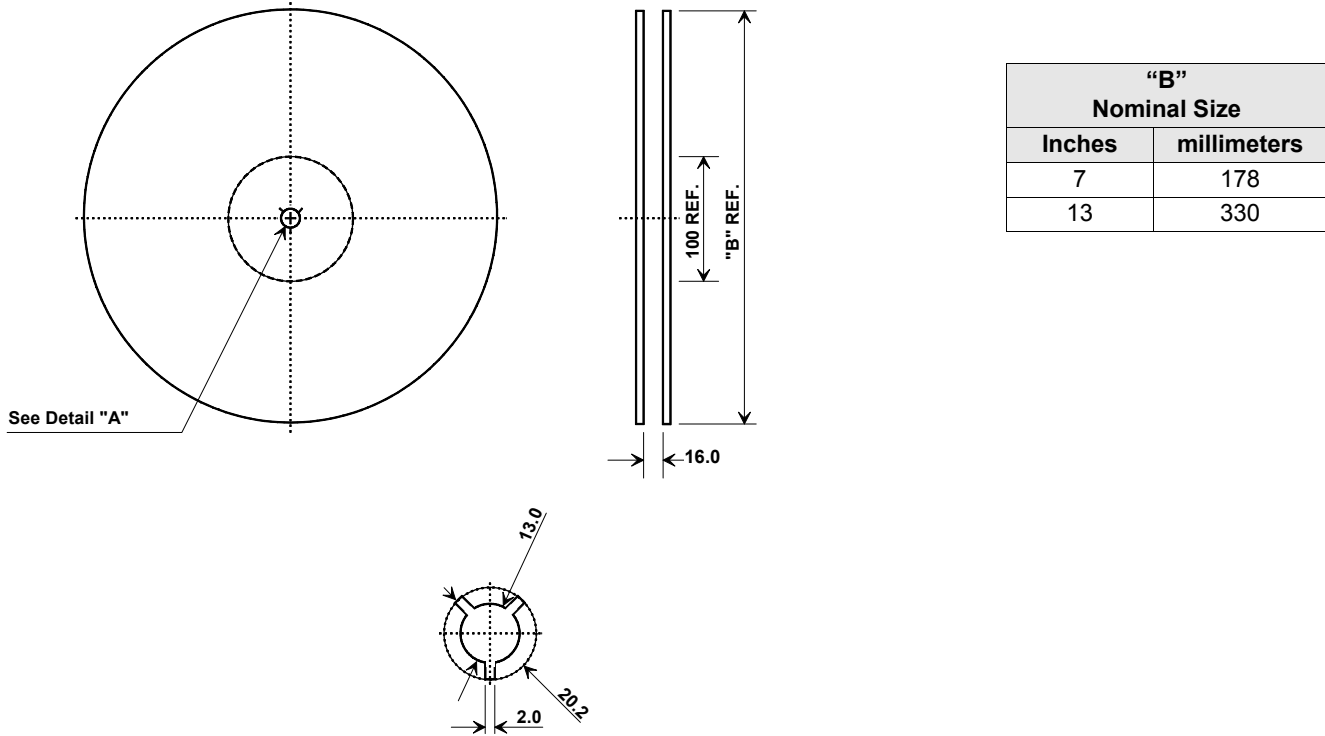

Component Orientation and Dimensions

