

SPECIFICATION FOR APPROVAL  
 \*\*\*\*\*

Customer:

Description:	EC FAN		
Customer P/N:		REV:	
Delta Model NO.:	GTB040FUC20R N1	Safety Model NO.:	GTB040FUC20
Sample Rev:	X05	Issue NO:	
Sample Issue Date:		Quantity:	

1. SCOPE:

THIS SPECIFICATION DEFINES THE ELECTRICAL AND MECHANICAL CHARACTERISTICS OF THIS CENTRIFUGAL FAN.

2. NOMINAL DATA:

UNLESS SPECIFIED, ALL READINGS AND TESTS ARE BASED ON 25 DEG C, 65% RH.

ITEM	DESCRIPTION
NOMINAL VOLTAGE	1 $\phi$ 230 VAC 50/60Hz
NOMINAL VOLTAGE RANGE	1 $\phi$ 200 - 277 VAC
INPUT POWER @ FREE-AIR	244 W
INPUT POWER @ MAX. LOAD	430 W
INPUT CURRENT (MAX)	3.10 A
SPEED	1600 R.P.M. (REF.)
MAX. AIR FLOW (AT ZERO STATIC PRESSURE)	3155 ( MIN. 2840) M <sup>3</sup> /H 1857 ( MIN. 1671) CFM
MAX. AIR PRESSURE (AT ZERO AIR FLOW)	562.9 ( MIN. 456.0) Pa 2.260 ( MIN. 1.831) inchH <sub>2</sub> O
ACOUSTICAL NOISE (AVG.) @ FREE-AIR	74.0 (MAX 79.0) dB(A)

- NOTES: 1. ALL READINGS ARE MEASURED AFTER STABLY WARMING UP THROUGH 10 MINUTES.  
 2. THE VALUES WRITTEN IN PARENS , ( ), ARE LIMITED SPEC.  
 3. ACOUSTICAL NOISE MEASURING CONDITION:

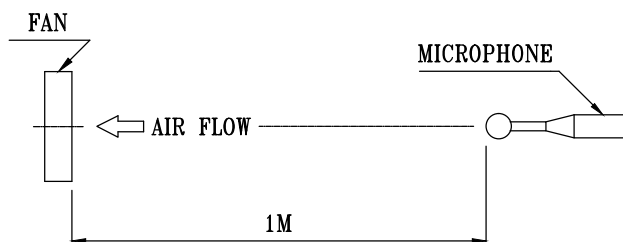

NOISE IS MEASURED AT NOMINAL VOLTAGE IN FREE AIR IN ANECHOIC CHAMBER WITH B & K SOUND LEVEL METER WITH MICROPHONE AT A DISTANCE OF ONE METER FROM THE FAN INTAKE.

PART NO:

DELTA MODEL: GTB040FUC20R N1

3. FEATURES:

DIRECTION OF ROTATION	CLOCKWISE, SEEN ON ROTOR
BEARING SYSTEM	BALL BEARINGS
WEIGHT	7.1 K.G. (REF.)
MATERIAL OF ELECTRONICS HOUSING	DIE-CAST ALUMINUM
MATERIAL OF IMPELLER	ALUMINUM SHEET
ELECTRICAL LEADS	LEAD WIRE
MOTOR PROTECTION	OVER TEMPERATURE PROTECTED
LEAKAGE CURRENT	$\leq 3.5$ mA
INSULATION CLASS	B
TYPE OF PROTECTION	IP54
PROTECTION CLASS	I
POWER FACTOR CORRECTION	PASSIVE
OPERATING TEMPERATURE	-25~+60 °C (REF.)
STORAGE TEMPERATURE	-40~+70 °C (REF.)
EMC	EN61000-6-1/3 , EN61000-3-2/3
SAFETY	UL , cUL , TUV
LIFE EXPECTANCE	* 60,000 HOURS CONTINOUS OPERATION AT 40 °C WITH 15 ~ 65 %RH.
FUNCTIONS	- CONTROL INPUT 0-10VDC or PWM PATTERN - OUTPUT +10VDC( $\pm 10\%$ ), max. 10mA - RS485 CONTROL BUS - ALARM RELAY, LOCKED ROTOR PROTECTION, SOFT START - VOLTAGE/CURRENT MONITORING

PART NO:

DELTA MODEL: GTB040FUC20R N1

4. P & Q CURVE:

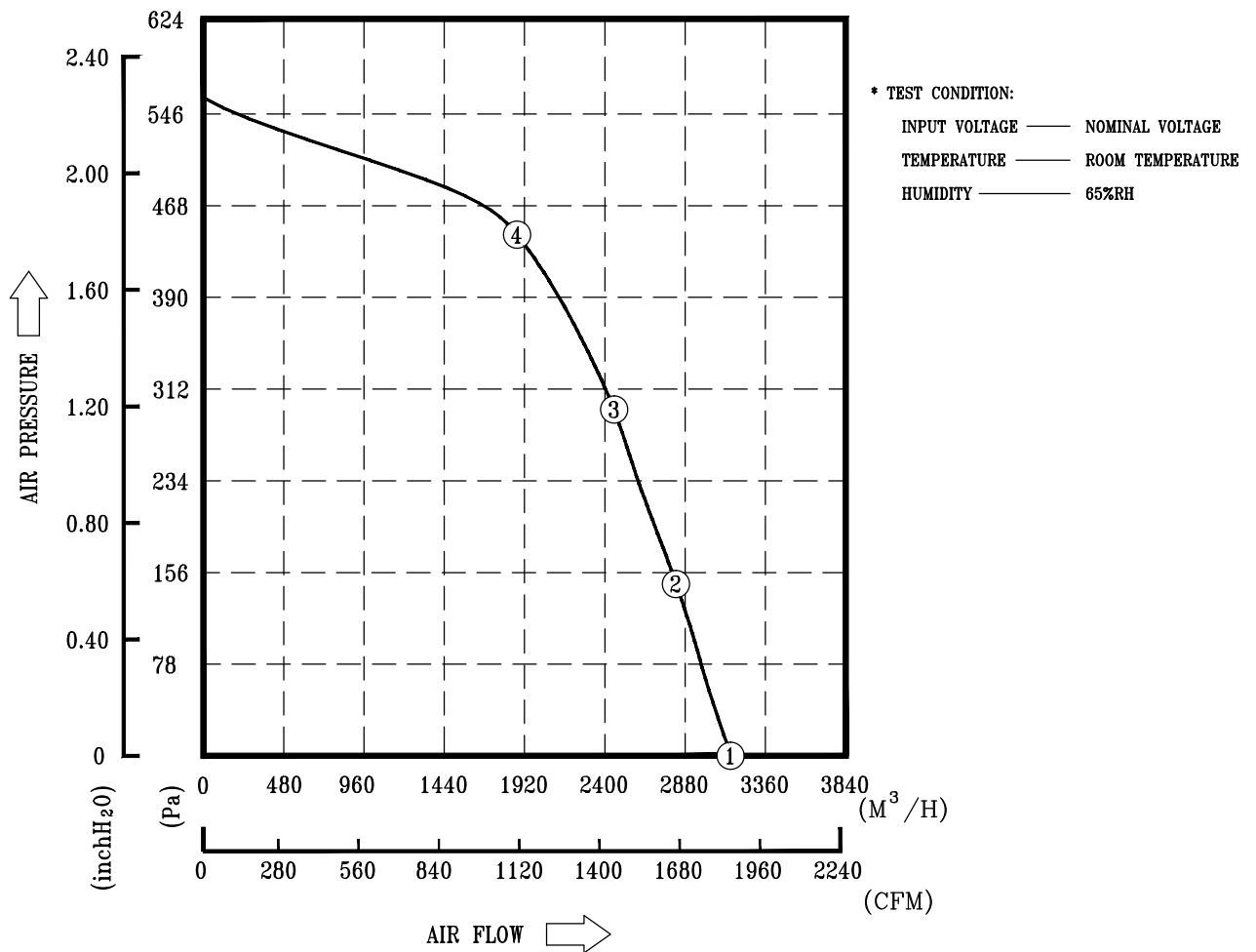

MEASURED DATA:

	P	Q	N	P1	I	Lp
	[Pa]	[M <sup>3</sup> /H]	[R.P.M.]	[W]	[A]	[dB(A)]
1	0	3155	1592	232	1.44	74.0
2	147.0	2832	1599	316	1.96	
3	296.5	2464	1600	381	2.37	
4	446.0	1890	1600	414	2.57	

PART NO:

DELTA MODEL: GTB040FUC20R N1

5. DIMENSION DRAWING:

LABEL

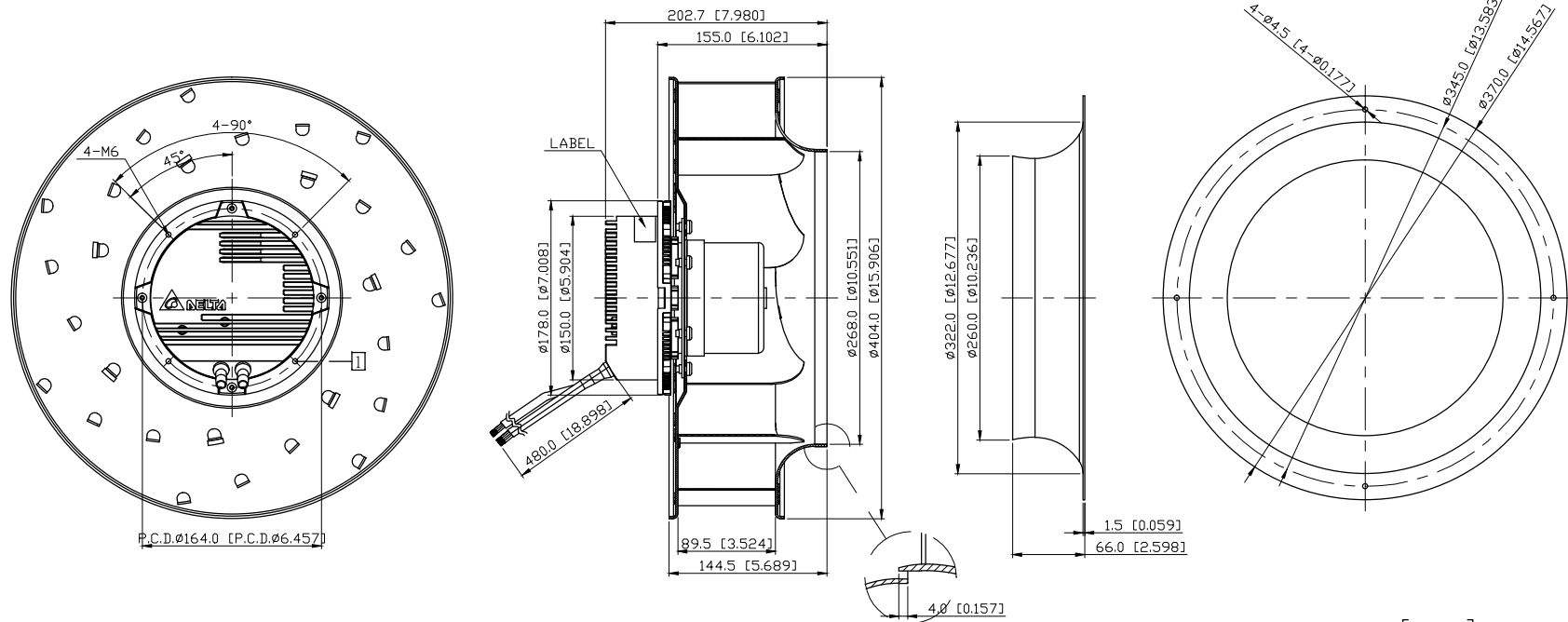
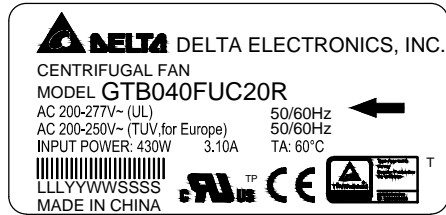

UNIT: mm [INCH]

NOTE:

1. DEPTH OF SCREW: 6~8mm.
2. THIS PRODUCT IS RoHS COMPLIANT.

-----  
PART NO:  
-----

DELTA MODEL: GTB040FUC20R N1  
-----

6. DEFINITION OF CABLE:

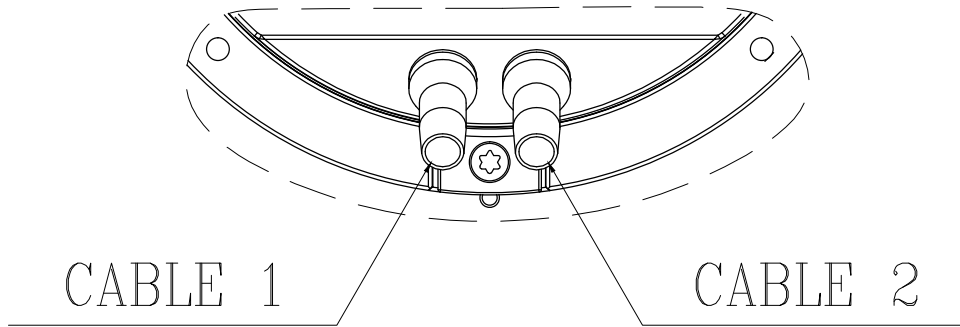

CABLE	COLOR	FUNCTIONS
1	BROWN	L
1	BLUE	N
1	GREEN/YELLOW	EARTH
<hr/>		
2	RED/PINK	+10V
2	BLUE/WHITE	PWM
2	BLACK	GND
2	GREEN/RED	RS485-
2	GREEN/WHITE	RS485+
2	PINK/BLACK	RELAY 1
2	GREEN/BLACK	RELAY 2

PART NO:

DELTA MODEL: GTB040FUC20R N1

7. LEAD WIRE CONNECTION:

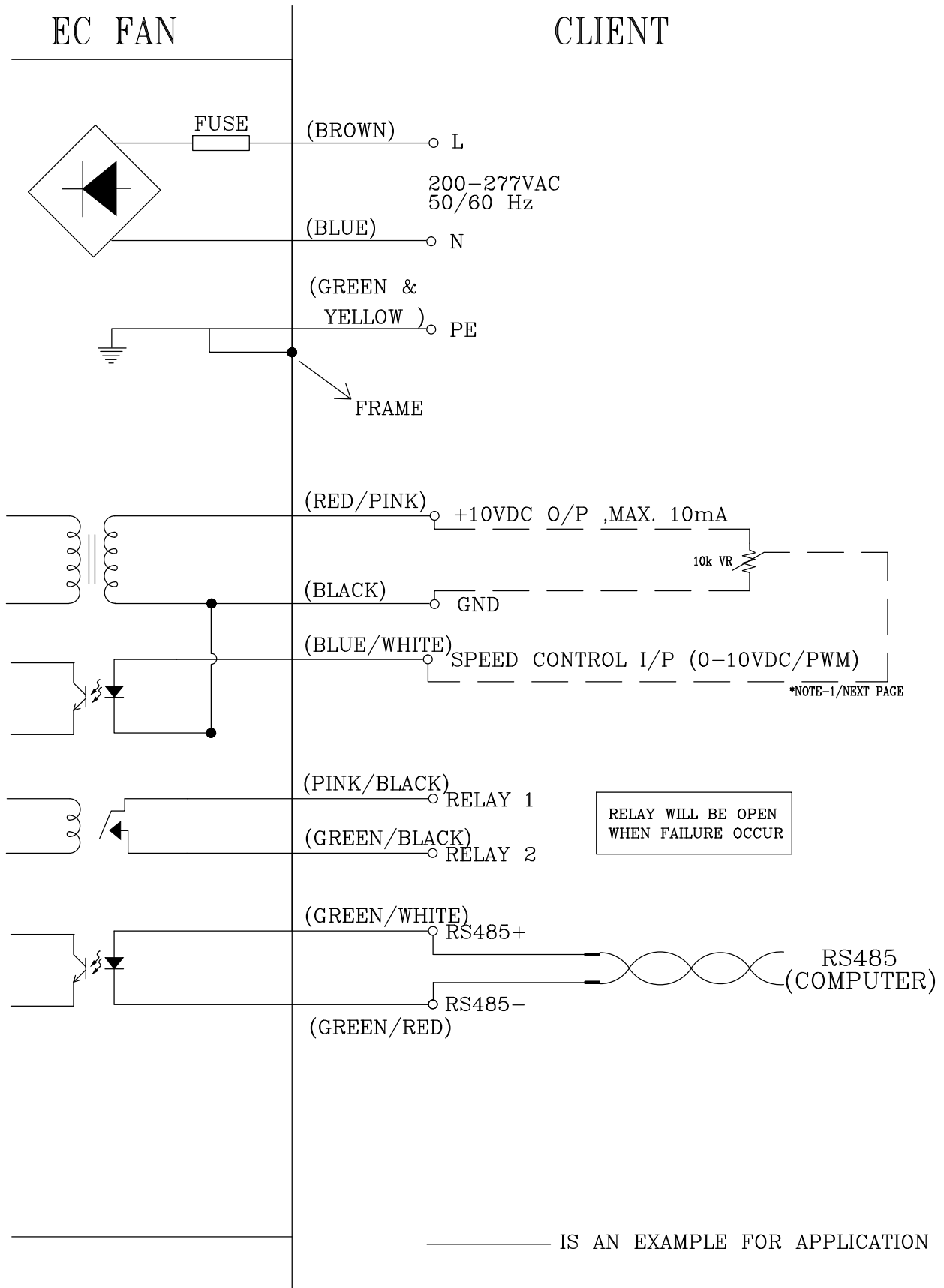

-----  
PART NO:  
-----

DELTA MODEL: GTB040FUC20R N1  
-----

8. FUNCTION CONTROL: VOLTAGE CONTROL

\*NOTE-1: SPEED CONTROL SIGNAL

A. VOLTAGE CONTROL

- CONTROL VOLTAGE RANGE SHALL BE 0-10 VDC.
- VOLTAGE AT 10 VDC THE FAN WILL SPIN AT MAXIMUM SPEED.
- VOLTAGE HIGHER THAN 1.5 VDC, THE FAN WILL START UP.
- VOLTAGE LOWER THAN 0.5 VDC, THE FAN WILL STOP.

B. PWM CONTROL

- THE AMPLITUDE VOLTAGE SHALL BE 10VDC. (100Hz~100kHz)

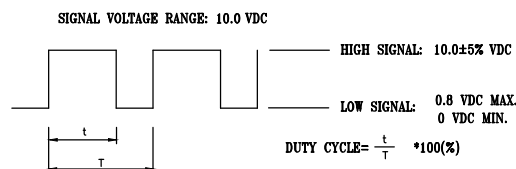

- PWM DUTY HIGHER THAN 15 % , THE FAN WILL START UP.
- PWM DUTY LOWER THAN 5 % , THE FAN WILL STOP.

- THE SPEED COMPARISON WITH CONTROL LEVEL:

VOLTAGE(V)	PWM DUTY(%)	SPEED (R.P.M.) (REF.)
0.0	0	0
9.5	95	1600

PART NO:

DELTA MODEL: GTB040FUC20R N1

9. CONTROL LEVEL & SPEED CURVE:

