

British Standard Motor Fuse Links

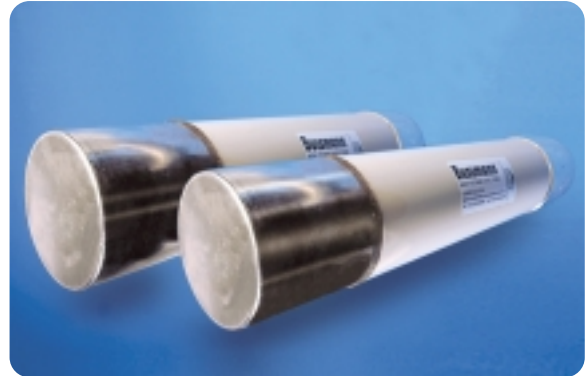

North American Motor Fuse Links



DIN Dimensioned Motor Fuse Links



- Motor fuse links comply with IEC60282-1, IEC644 and BS5907.
- Available in DIN 43625 and BS2692 dimensions.
- Sold in a wide range of ratings from:
3.6 kV – 5 to 450 A
7.2 kV – 5 to 355 A
- North American dimensioned products also available. 2R to 24R ratings.

Bussmann Motor Fuse Links

The Bussmann range of motor fuse links are designed to meet the specific requirements necessary for motor protection. During the starting cycle of direct on-line motors, the fuse elements will reach a considerably higher temperature than during normal operation; (this is due to the the high amount of current the motor will draw as it starts, typically, 6 times its normal load current value). This results in expansion and contraction of the fuse elements and could cause premature operation of the fuse.

Bussmann motor fuse links encompass an advanced design to minimise this effect. This therefore, negates the need to over specify the fuse rating due to high values of of motor starting current.

Bussmann motor fuse links operate extremely quickly under heavy fault currents, resulting from the time / current characteristic. Low power dissipation ensures low temperature rise, important in multi-tier starters for example. Switching (Arc), voltages are lower than permitted values, therefore, 5.5kV fuses are also suitable for 4.8kV and 2.4kV circuits.

■ Application

Fuse Links provide short circuit protection in motor circuits to both the motor starter and cables from the starter to the motor. Overload protection is provided by the motor starter, generally by an overload relay and contactor. Combination striker tripping may also form part of associated equipment which houses the fuse links and motor starters.

■ Application Procedure

For any motor the fuse current rating is determined by magnitude and duration of starting current, except in a few situations where the starting currents are very light. The fuse current rating should therefore be selected as follows:

■ Direct-on-line Starting

In the absence of specific information the starting current can usually be taken to be six times the motor's full load current. The starting time will depend on the type of the drive but will be approximately as follows:

Pump Motors - 6 seconds

Mill Motors - 10 to 15 seconds

Fan Motors - 60 seconds

These are average values and the appropriate figures for starting current and starting time for actual installation should be obtained wherever possible.

Multiply the starting current by 1.7 and using this value of current and the starting time, (it is recommended that a minimum time of 5 seconds be adopted), plot this point on the time-current characteristics of the fuse link. The correct current rating of the fuse is then chosen as being the one immediately to the right of the point so plotted. The chosen fuse must also have a current rating of at least 1.3 times the full-load current of the associated motor.

The rating chosen will be adequate for normal applications where the associated motor is not started more than twice in given period of one hour.

For applications using more frequent starting duties, a greater derating factor must be applied as shown in the following table.

Maximum 2 starts per hour - Derating factor 1.7	Maximum 8 starts per hour - Derating factor 2.1
Maximum 4 starts per hour - Derating factor 1.9	Maximum 16 starts per hour - Derating factor 2.4

■ Assisted Starting

A similar method of fuse selection may be used as for direct-on-line starting (see above), but it must be noted that the normal running current of the motor is likely to be closer in value to the nominal current rating of the fuse than for direct-on-line applications.

The rating of fuse chosen will need to be appreciably greater than the motor running current to allow for restricted cooling inside control gear cubicles, particularly where multi-tier starters are involved. In case of doubt refer to Bussmann for further guidance.

■ Note

For applications involving more frequent starting duties than 16 times per hour or where unusual duty cycles are involved, consult Bussmann application engineers for advice.

Selection Tables

Table of ratings for motor fuses 3.6 - 7.2kV to British Standard dimensions

Part Number	Voltage Rating	Current Rating	Breaking Capacity	Minimum Breaking Current	Cold resistance and watts loss in free air at rated current		Joule Intergral (I ² t)		Length mm	Diameter Ø mm	Weight kg
	U _n kV	I _n A	I ₁ kA	I ₃ A	m Ω	W	A ² s				
	Minimum Pre-Arcing	Maximum Total Clearing									
3.6WJON65	3.6	5	50	13	148	5	2.0X10 ¹	1.6X10 ³	192	35	0.54
3.6WJON66.3	3.6	6.3	50	24	56.3	8	1.6X10 ²	1.3X10 ³	192	35	0.54
3.6WJON610	3.6	10	50	24	56.3	8	1.6X10 ²	1.3X10 ³	192	35	0.54
3.6WJON616	3.6	16	50	56	33.1	12	1.7X10 ²	1.4X10 ³	192	35	0.54
3.6WJON620	3.6	20	50	56	22.1	12	3.9X10 ²	3.2X10 ³	192	35	0.54
3.6WJON625	3.6	25	50	70	17.7	15	6.1X10 ²	4.9X10 ³	192	35	0.54
3.6WJON631.5	3.6	31.5	50	112	10.1	14	1.2X10 ³	9.8X10 ³	192	35	0.54
3.6WJON640	3.6	40	50	112	7.54	17	2.1X10 ³	1.7X10 ⁴	192	35	0.54
3.6WJON650	3.6	50	50	140	6.03	21	3.2X10 ³	2.6X10 ⁴	192	35	0.54
3.6WDOH650	3.6	50	50	180	5.36	20	1.8X10 ³	2.4X10 ⁴	192	51	1.1
3.6WDOH663	3.6	63	50	225	3.68	21	3.8X10 ³	4.5X10 ⁴	192	51	1.1
3.6WDOH680	3.6	80	50	288	2.88	27	6.3X10 ³	8.0X10 ⁴	192	51	1.1
3.6WDOH6100	3.6	100	50	360	2.16	31	9.8X10 ³	1.1X10 ⁵	192	51	1.1
3.6WDOH6125	3.6	125	50	450	1.73	39	1.5X10 ⁴	2.2X10 ⁵	192	51	1.1
3.6WFOH6160	3.6	160	50	600	1.28	47	3.1X10 ⁴	6.2X10 ⁵	192	76	2.1
3.6WFOH6200	3.6	200	50	600	0.938	52	5.7X10 ⁴	1.1X10 ⁶	192	76	2.1
3.6WDFHO50	3.6	50	50	152	6.61	21	1.8X10 ³	2.4X10 ⁴	254	51	1.46
3.6WDFHO63	3.6	63	50	171	5.03	28	3.1X10 ³	4.5X10 ⁴	254	51	1.46
3.6WDFHO80	3.6	80	50	190	3.52	31	6.3X10 ³	8.0X10 ⁴	254	51	1.46
3.6WDFHO100	3.6	100	50	190	2.87	39	9.5X10 ³	1.2X10 ⁵	254	51	1.46
3.6WDFHO125	3.6	125	50	190	2.44	53	1.3X10 ⁴	1.8X10 ⁵	254	51	1.46
3.6WFFHO160	3.6	160	50	300	1.53	54	3.4X10 ⁴	4.1X10 ⁵	254	76	3.2
3.6WFFHO200	3.6	200	50	300	1.24	67	5.1X10 ⁴	7.2X10 ⁵	254	76	3.2
3.6WKFOH250	3.6	250	50	520	0.653	57	1.8X10 ⁵	2.4X10 ⁶	254	76	3.2
3.6WKFOH315	3.6	315	50	650	0.435	60	4.1X10 ⁵	5.0X10 ⁶	254	76	3.2
3.6WKFOH355	3.6	355	50	820	0.345	59	6.4X10 ⁵	7.0X10 ⁶	254	76	3.2
3.6WKFOH400	3.6	400	50	820	0.345	76	6.4X10 ⁵	7.0X10 ⁶	254	76	3.2
3.6WFGHO31.5	3.6	31.5	50	151	18.4	25	4.5X10 ²	6.0X10 ³	359	76	4.1
3.6WFGHO40	3.6	40	50	151	13.9	31	8.0X10 ²	1.2X10 ⁴	359	76	4.1
3.6WFGHO50	3.6	50	50	151	9.24	32	1.8X10 ³	2.2X10 ⁴	359	76	4.1
3.6WFGHO63	3.6	63	50	151	6.93	38	3.2X10 ³	4.5X10 ⁴	359	76	4.1
3.6WFGHO80	3.6	80	50	170	5.47	48	5.1X10 ³	7.5X10 ⁴	359	76	4.1
3.6WFGHO100	3.6	100	50	212	4.40	62	7.9X10 ³	1.2X10 ⁵	359	76	4.1
3.6WFGHO125	3.6	125	50	212	3.60	79	1.2X10 ⁴	1.7X10 ⁵	359	76	4.1
3.6WFGHO160	3.6	160	50	300	2.16	75	3.4X10 ⁴	4.2X10 ⁵	359	76	4.1
3.6WFGHO200	3.6	200	50	300	1.77	95	5.1X10 ⁴	7.0X10 ⁵	359	76	4.1
3.6WFGHO250	3.6	250	50	500	1.13	96	1.3X10 ⁵	1.9X10 ⁶	359	76	4.1
3.6WKGHO315	3.6	315	50	852	0.646	89	4.5X10 ⁵	6.0X10 ⁶	359	76	3.9
3.6WKGHO355	3.6	355	50	852	0.512	90	6.4X10 ⁵	8.5X10 ⁶	359	76	3.9
3.6WKGHO400	3.6	400	50	960	0.454	100	8.2X10 ⁵	1.1X10 ⁷	359	76	3.9
3.6WKGHO450	3.6	450	50	1150	0.379	108	1.2X10 ⁶	1.5X10 ⁷	359	76	3.9
7.2WFNHO25	7.2	25	40	84	38.7	34	1.4X10 ²	2.1X10 ³	403	76	4.4
7.2WFNHO31.5	7.2	31.5	40	96	25.5	35	3.1X10 ²	4.7X10 ³	403	76	4.4
7.2WFNHO40	7.2	40	40	107	18.2	40	6.1X10 ²	8.0X10 ³	403	76	4.4
7.2WFNHO50	7.2	50	40	122	13.3	46	1.2X10 ³	1.5X10 ⁴	403	76	4.4
7.2WFNHO63	7.2	63	40	133	10.4	56	1.9X10 ³	3.0X10 ⁴	403	76	4.4
7.2WFNHO80	7.2	80	40	133	7.30	65	3.8X10 ³	5.8X10 ⁴	403	76	4.4
7.2WFNHO100	7.2	100	40	262	4.92	69	9.8X10 ³	1.3X10 ⁵	403	76	4.4
7.2WFNHO125	7.2	125	40	300	2.94	63	2.4X10 ⁴	2.4X10 ⁵	403	76	4.4
7.2WFNHO160	7.2	160	40	337	2.05	72	5.0X10 ⁴	7.0X10 ⁵	403	76	4.4
7.2WKNHO200	7.2	200	40	500	1.63	90	8.8X10 ⁴	1.3X10 ⁶	403	76	4.4
7.2WKNHO224	7.2	224	40	500	1.44	98	1.1X10 ⁵	1.6X10 ⁶	403	76	4.4
7.2WKNHO250	7.2	250	40	960	1.11	105	2.2X10 ⁵	1.6X10 ⁶	403	76	4.4
7.2WKNHO315	7.2	315	40	960	0.779	107	4.5X10 ⁵	3.1X10 ⁶	403	76	4.4

■ WDOH6 fuse links also available in the range 6.3 to 40A as code ADOH6.

Table of ratings for motor fuses 3.6 - 7.2kV to DIN dimensions

Part Number	Voltage Rating	Current Rating	Breaking Capacity	Minimum Breaking Current	Cold resistance and watts loss in free air at rated current		Joule Integral (I ² t)		Length	Diameter Ø	Weight
	U _n	I _n	I ₁	I ₃	m Ω	W	A ² s		mm	mm	kg
	kV	A	kA	A			Minimum Pre-Arcing	Maximum Total Clearing			
3.6WDOSJ50	3.6	50	50	180	5.36	20	1.8X10 ³	2.4X10 ⁴	192	51	1.1
3.6WDOSJ63	3.6	63	50	225	3.68	21	3.8X10 ³	4.5X10 ⁴	192	51	1.1
3.6WDOSJ80	3.6	80	50	288	2.88	27	6.3X10 ³	8.0X10 ⁴	192	51	1.1
3.6WDOSJ100	3.6	100	50	360	2.16	31	9.8X10 ³	1.1X10 ⁵	192	51	1.1
3.6WDOSJ125	3.6	125	50	450	1.73	39	1.5X10 ⁴	2.2X10 ⁵	192	51	1.1
3.6WFOSJ160	3.6	160	50	600	1.28	47	3.1X10 ⁴	6.2X10 ⁵	192	76	2.1
3.6WFOSJ200	3.6	200	50	600	0.938	52	5.7X10 ⁴	1.1X10 ⁶	192	76	2.1
3.6WDLSJ50	3.6	50	50	152	7.73	27	1.8X10 ³	2.4X10 ⁴	292	51	1.63
3.6WDLSJ63	3.6	63	50	171	5.9	32	3.1X10 ³	4.5X10 ⁴	292	51	1.63
3.6WDLSJ80	3.6	80	50	190	4.12	37	6.3X10 ³	8.0X10 ⁴	292	51	1.63
3.6WDLSJ100	3.6	100	50	190	3.38	46	9.5X10 ³	1.2X10 ⁵	292	51	1.63
3.6WDLSJ125	3.6	125	50	190	2.85	61	1.3X10 ⁴	1.8X10 ⁵	292	51	1.63
3.6WFLSJ160	3.6	160	50	300	1.74	61	3.4X10 ⁴	4.1X10 ⁵	292	76	3.16
3.6WFLSJ200	3.6	200	50	300	1.42	80	5.1X10 ⁴	7.2X10 ⁵	292	76	3.16
3.6WKLSJ250	3.6	250	50	820	0.741	67	1.9X10 ⁵	2.4X10 ⁶	292	76	3.16
3.6WKLSJ315	3.6	315	50	820	0.507	69	4.0X10 ⁵	5.0X10 ⁶	292	76	3.16
3.6WKLSJ400	3.6	400	50	820	0.401	90	6.4X10 ⁵	7.0X10 ⁶	292	76	3.16
7.2WFMSJ25	7.2	25	63	84	33.9	33	1.4X10 ²	2.1X10 ³	442	76	5.2
7.2WFMSJ31.5	7.2	31.5	63	96	25.4	40	3.1X10 ²	4.7X10 ³	442	76	5.2
7.2WFMSJ40	7.2	40	63	107	17.8	56	6.1X10 ²	8.0X10 ³	442	76	5.2
7.2WFMSJ50	7.2	50	63	122	14.8	53	1.2X10 ³	1.5X10 ⁴	442	76	5.2
7.2WFMSJ63	7.2	63	63	133	11.6	61	1.9X10 ³	3.0X10 ⁴	442	76	5.2
7.2WFMSJ80	7.2	80	63	133	8.12	72	3.8X10 ³	5.8X10 ⁴	442	76	5.2
7.2WFMSJ100	7.2	100	63	262	5.33	74	9.8X10 ³	1.3X10 ⁵	442	76	5.2
7.2WFMSJ125	7.2	125	63	300	3.19	70	2.4X10 ⁴	2.4X10 ⁵	442	76	5.2
7.2WFMSJ160	7.2	160	63	337	2.23	79	5.0X10 ⁴	7.0X10 ⁵	442	76	5.2
7.2WKMSJ200	7.2	200	63	500	1.79	99	8.8X10 ⁴	1.3X10 ⁶	442	76	5.2
7.2WKMSJ224	7.2	224	63	500	1.59	110	1.1X10 ⁵	1.6X10 ⁶	442	76	5.2
7.2WKMSJ250	7.2	250	63	960	1.23	107	2.2X10 ⁵	1.6X10 ⁶	442	76	5.2
7.2WKMSJ315	7.2	315	63	960	0.869	120	4.5X10 ⁵	3.1X10 ⁶	442	76	5.2
7.2WKMSJ355	7.2	355	63	1000	0.724	125	6.4X10 ⁵	3.9X10 ⁶	442	76	5.2

■ Higher Current Ratings

Higher ratings than those tabulated above can be obtained by using fuse links connected in parallel. Special fixing arrangements for connecting up to 3 fuse links in parallel, are available. Please contact Bussmann application engineers for more details. The code designations for these arrangements are given in 'How to Order' (page 61), dimensional drawings are given on page 26.

Table of ratings for motor fuses 2.75 - 5.5kV to USA dimensions

Part Number	Voltage Rating	Current Rating	Breaking Capacity	Minimum Breaking Current	Cold resistance and watts loss in free air at rated current		Joule Integral (I ² t)		Length	Diameter Ø	Weight
	U _n	I _n	I ₁	I ₃	m Ω	W	A ² s		mm	mm	kg
	kV	A	kA	A			Minimum Pre-Arcing	Maximum Total Clearing			
2.75VFRHA*R	2.75	2R	60	180	6.15	52	8.1x10 ³	2.8x10 ⁴	276	76	2.5
2.75VFRHA*R	2.75	3R	60	229	4.04	57	1.9x10 ⁴	7.5x10 ⁴	276	76	2.5
2.75VFRHA*R	2.75	4R	60	257	2.69	62	4.2x10 ⁴	1.4x10 ⁵	276	76	2.5
2.75VFRHA*R	2.75	6R	60	525	1.62	65	3.9x10 ⁴	3.4x10 ⁵	276	76	2.5
2.75VKRHA*R	2.75	9R	60	500	1.15	70	8.8x10 ⁴	8.4x10 ⁵	276	76	2.5
2.75VKRHA*R	2.75	12R	60	500	1.03	80	1.1x10 ⁵	1.2x10 ⁶	276	76	2.5
2.75VKRHK*R	2.75	18R	60	500	0.577	140	3.5x10 ⁵	3.2x10 ⁶	276	76	5.2
2.75VKRHK*R	2.75	24R	60	500	0.514	156	4.5x10 ⁵	5.5x10 ⁶	276	76	5.2
5.5VFNHA*R	5.5	2R	60	180	8.35	70	8.1x10 ³	2.8x10 ⁴	403	76	3.8
5.5VFNHA*R	5.5	3R	60	229	5.48	77	1.9x10 ⁴	7.9x10 ⁴	403	76	3.8
5.5VFNHA*R	5.5	4R	60	257	3.65	85	4.2x10 ⁴	1.6x10 ⁵	403	76	3.8
5.5VFNHA*R	5.5	6R	60	525	2.31	91	3.9x10 ⁴	3.6x10 ⁵	403	76	3.8
5.5VKNHA*R	5.5	9R	60	500	1.63	99	8.8x10 ⁴	8.8x10 ⁵	403	76	3.8
5.5VKNHA*R	5.5	12R	60	500	1.45	110	1.1x10 ⁵	1.3x10 ⁶	403	76	3.8
5.5VKNHK*R	5.5	18R	60	500	0.815	198	3.5x10 ⁵	3.4x10 ⁶	403	76	7.8
5.5VKNHK*R	5.5	24R	60	500	0.725	220	4.5x10 ⁵	5.8x10 ⁶	403	76	7.8

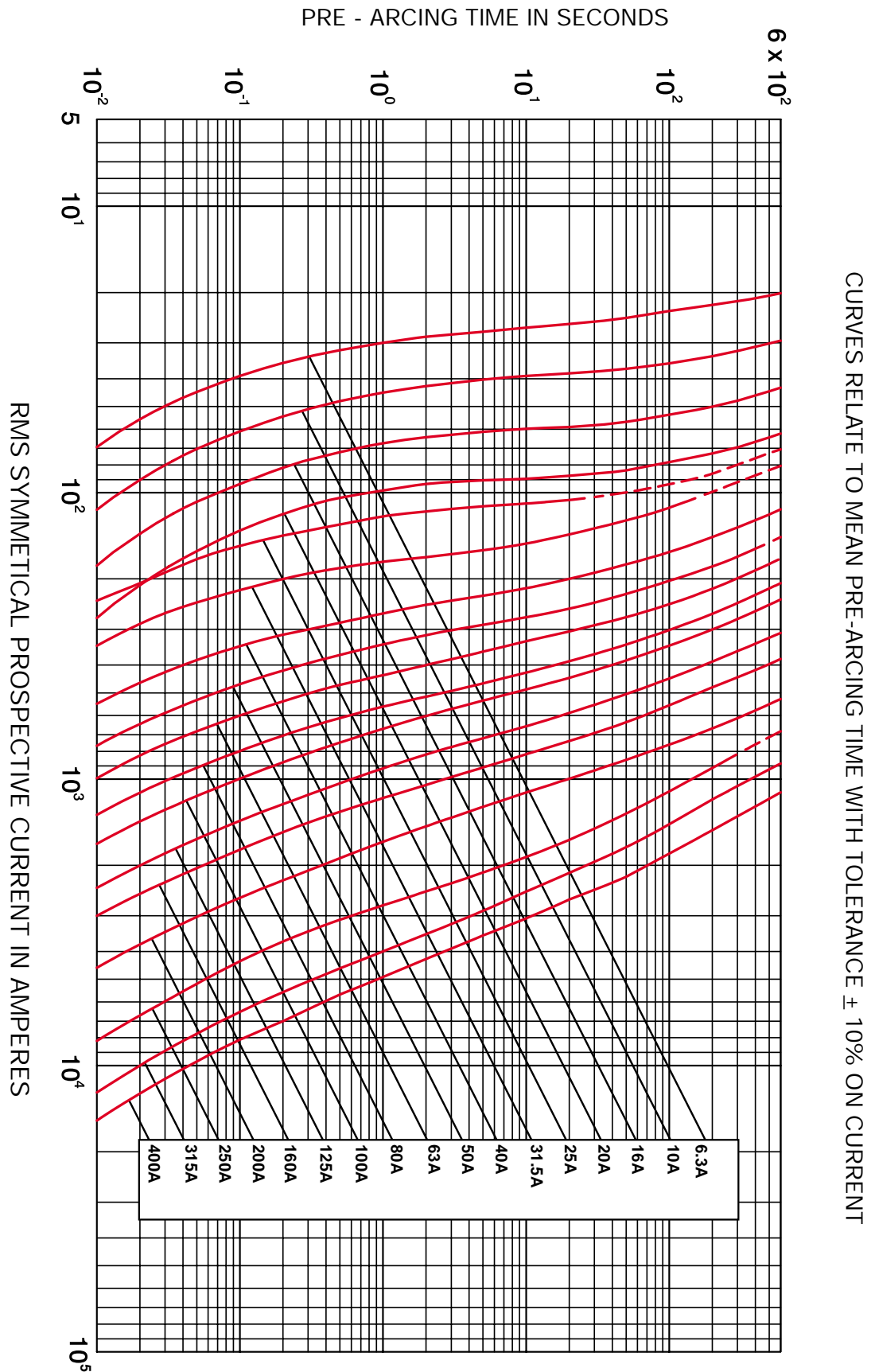

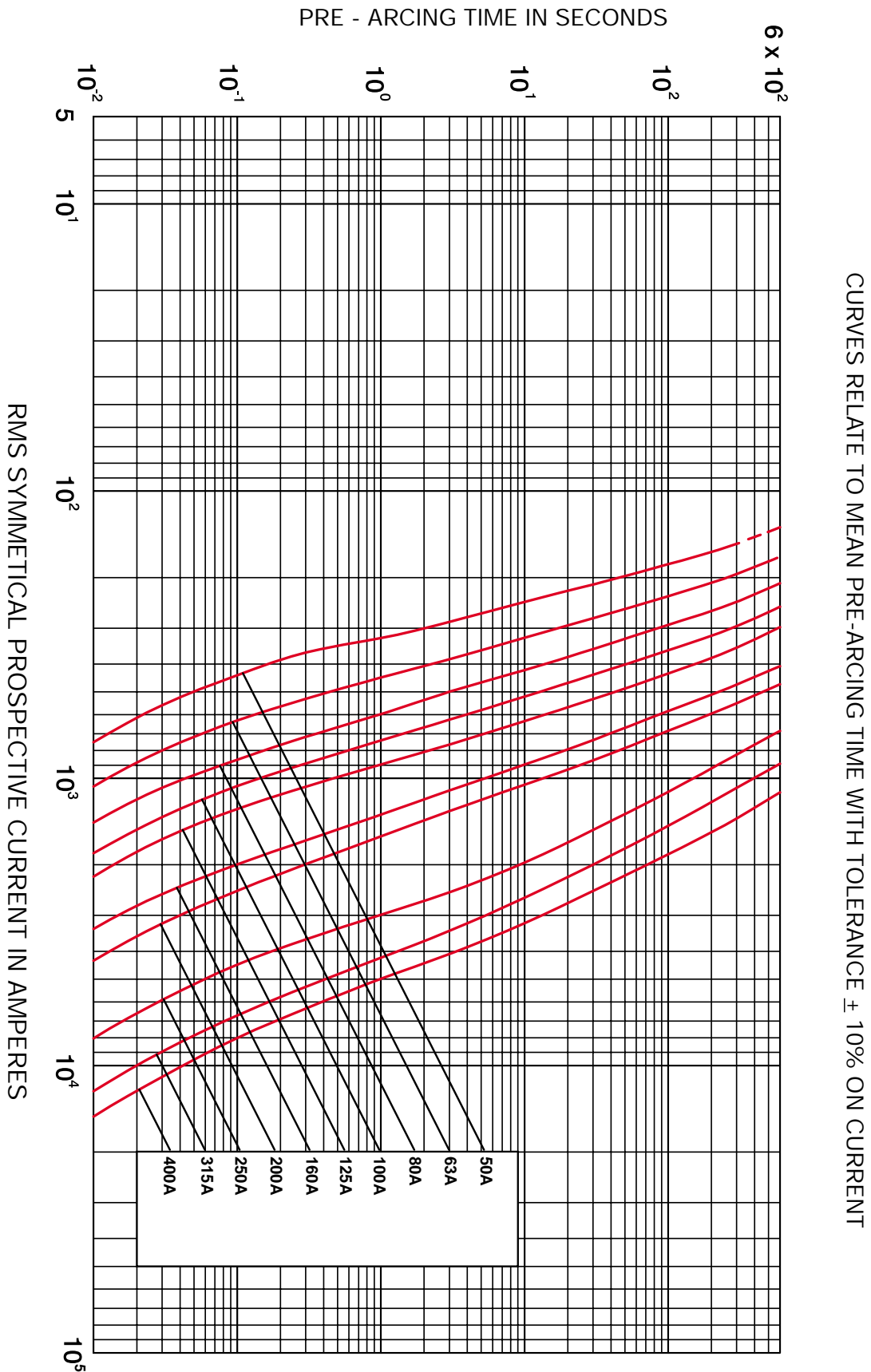

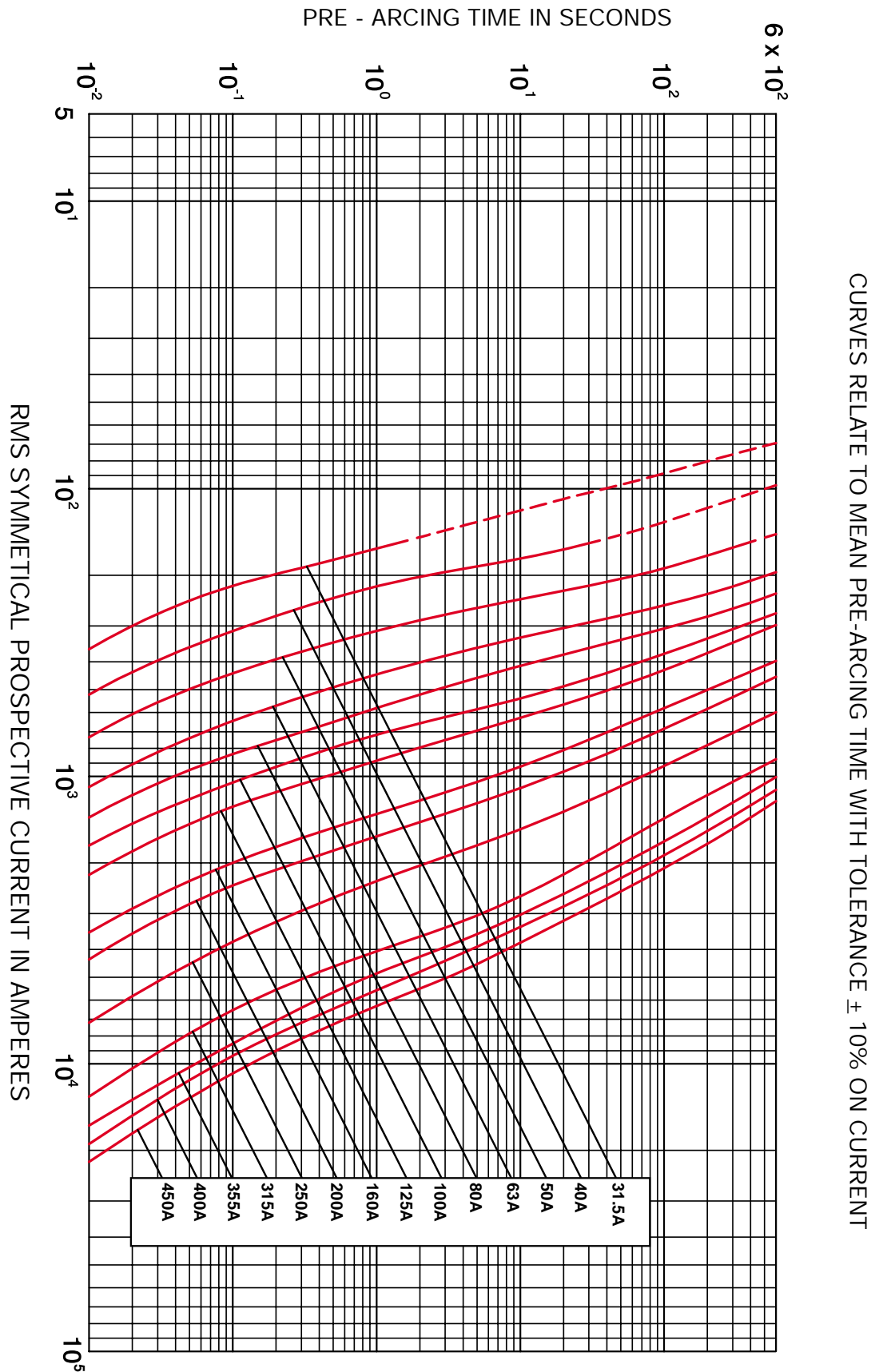

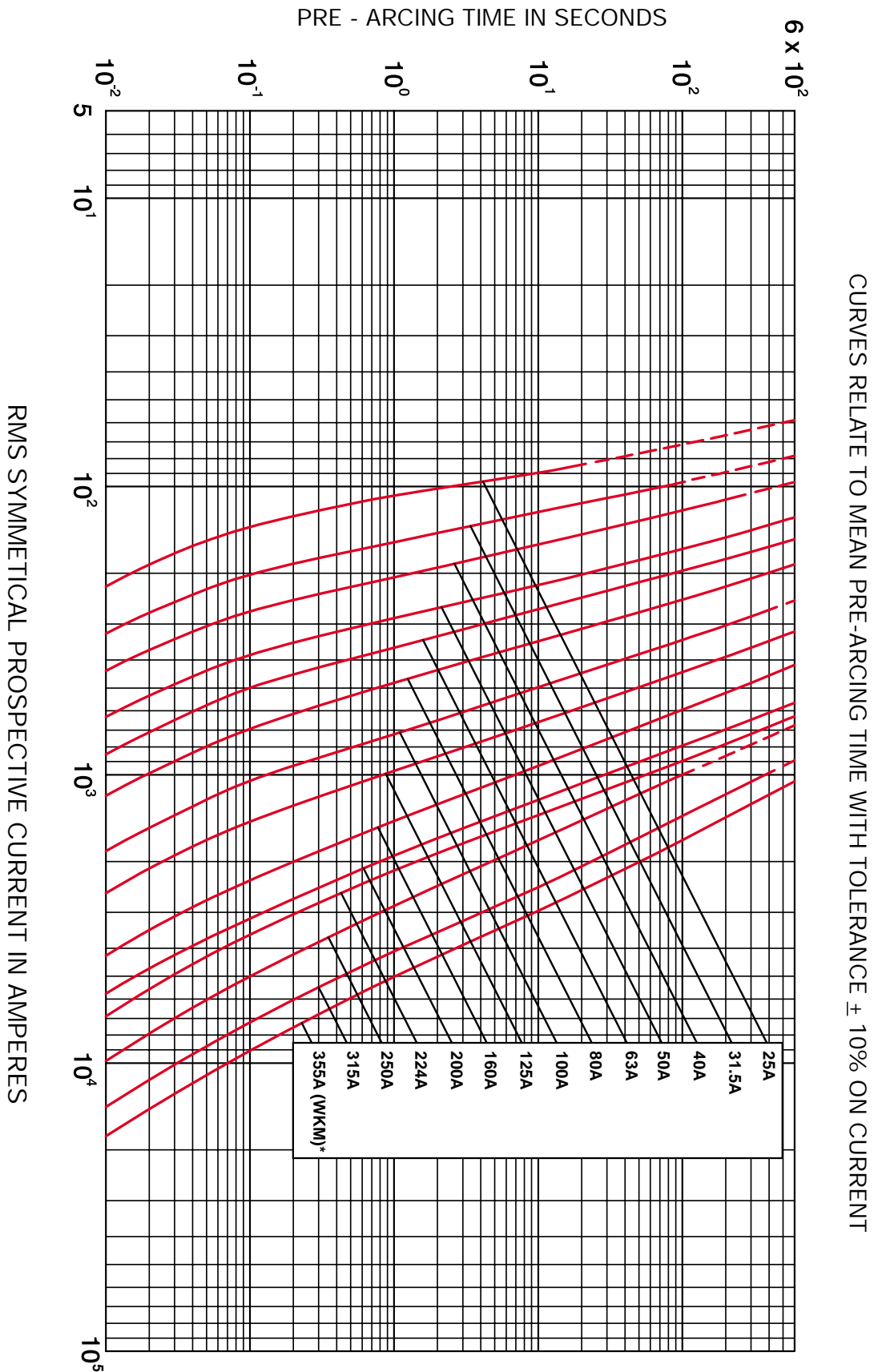

Fuse Link type: DIN

FUSE LINK TYPE	A	D
WDOSJ	192	51
WDLSJ	292	51
WFOSJ	192	76
WFLSJ	292	76
WKLSJ	292	76
WFMSJ	442	76
WKMSJ	442	76

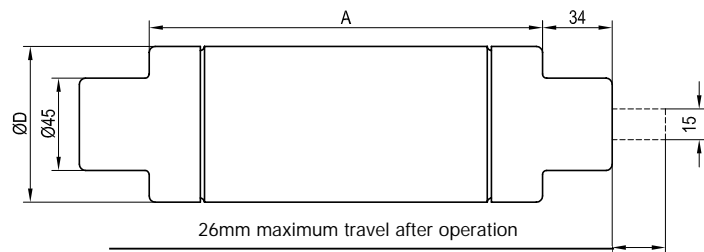

Fuse Link type: Tag Type "6" - BS 2692 Standard

FUSE LINK TYPE	A	B	C	D	E	F	G	H	J
+WJON6	257	235	192	36	9.5	13	25	23	2.4
WDO*H6	261	235	192	51	10.5	13	25	29	2.6
WFO*H6	261	235	192	76	10.5	20	64	42	2.6

+ Fuse type not available with striker

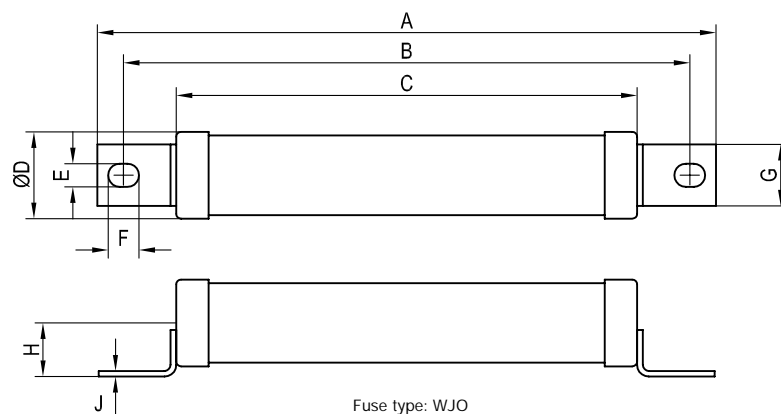

Fuse type: WJO

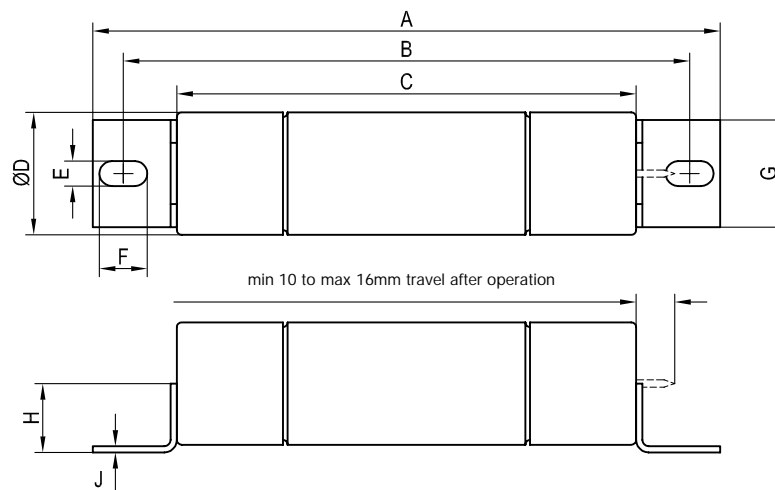

Fuse type: WDO, WFO

Dimensions in mm

Fuse Link type: Tag Type "0" - BS 2692 Standard

FUSE LINK TYPE	A	B	C	D
WDFHO	337	305	254	51
WFFHO	337	305	254	76
WKFHO	337	305	254	76
WFGHO	442	410	359	76
WKGHO	442	410	359	76
WFNHO	486	454	403	76
WKNHO	486	454	403	76

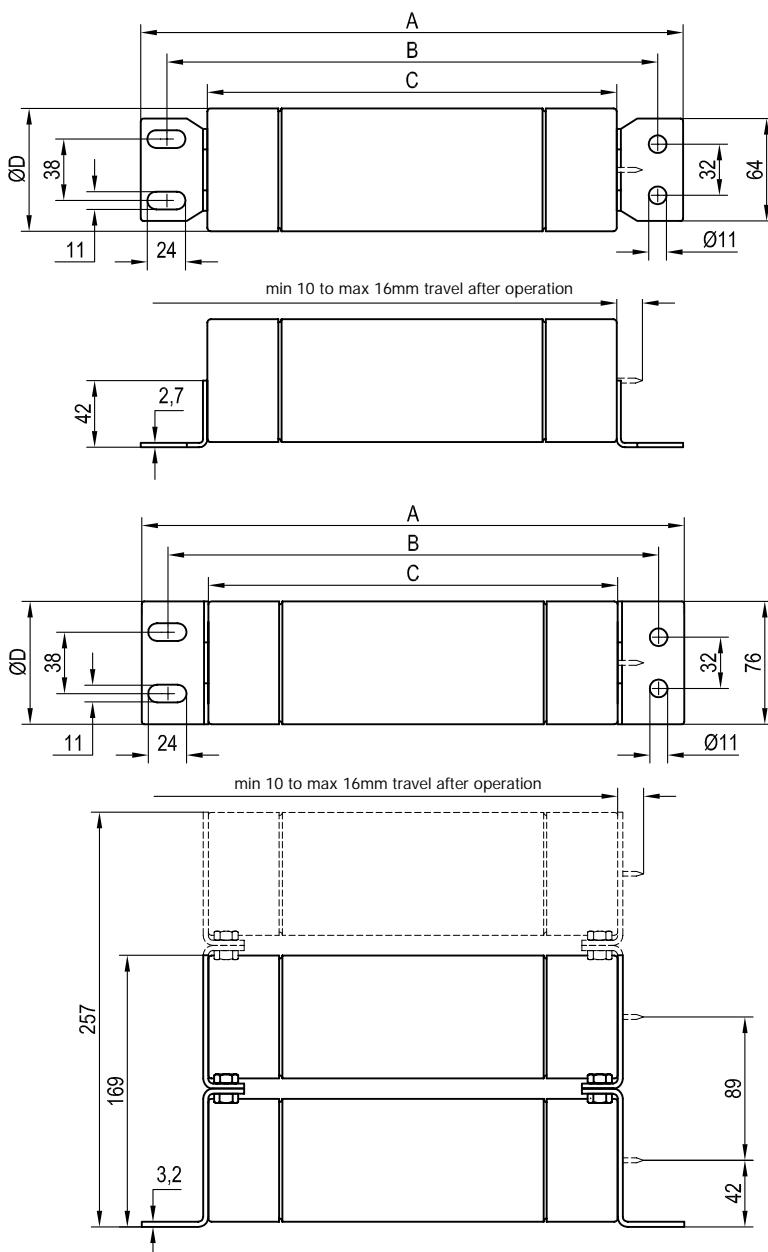

Triple barrel fuse link
(3rd barrel shown dotted) with 03 tags.
Double barrel fuse link with 02 tags
shown in full lines.

Fuse Link type: USA Motor

A Tags (ferrule)

FUSE LINK TYPE	A
VFRHA	276
VKRHA	276
VKRHK	276
VFNHA	403
VKNHA	403
VKNHK	403

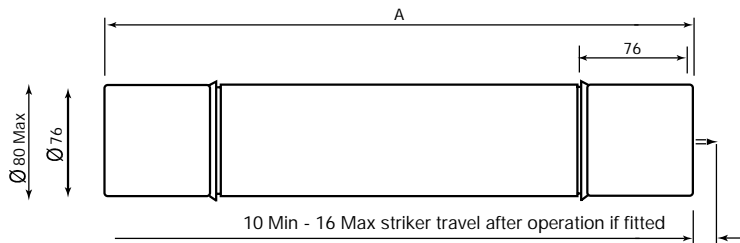

K Tags (Double barrel fuse links)

FUSE LINK TYPE	A
VFRHA	276
VKRHA	276
VKRHK	276
VFNHA	403
VKNHA	403
VKNHK	403

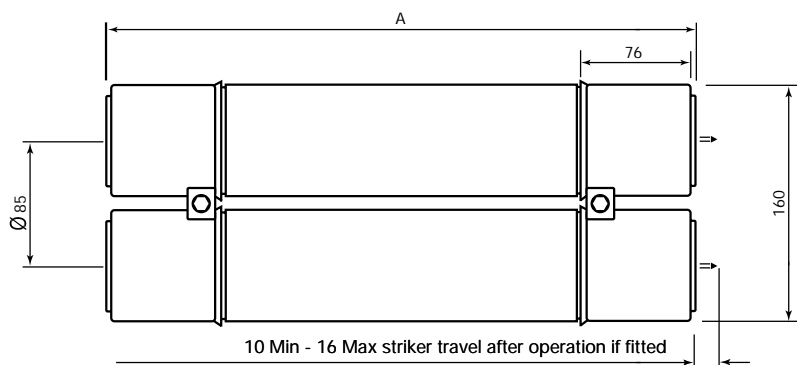

K Tags (Double barrel fuse links)